

ミスミ

φ30 非照光 PB3シリーズ



**ココが特長**  
**操作しやすい取付穴φ30の大型非照光タイプ**  
 ●海外規格No.は ②13ページ参照  
 ●製造元型番は ②13ページ参照

IP65

在庫品

RoHS



・スイッチ回路の使用条件毎の定格は下記詳細仕様をご覧ください。



基本型番 - 色  
**PB3CFM10** - **R**



1個単位

仕様グループ	基本型番	色	形状	操作部	動作機能	構成	構造	保護構造	取得規格					端子	仕様グループ	¥パラチャージ 1~2個	¥通常単価 3~9個	¥ストライド単価 10~19個																														
									UL	CSA	TUV	CE	CCC																																			
スイッチ	PB3CFM10	R	丸形	φ24	モメンタリ	1a	分離	IP65f	●	●	●	●	●	A	+420/個																																	
	PB3CFM11	G																	φ25	オルタネイト	1a1b	一体	●	●	●	●	●	●	B																			
	PB3CF2M10	B																																φ24	モメンタリ	1a	分離	●	●	●	●	●	●	A				
	PB3CF2M11	黒																																														
	PB3CF2A10	黒																																φ29	モメンタリ	1a	分離	●	●	●	●	●	●	A				
	PB3CF2A11	黄		φ40	モメンタリ	1a1b	分離												●	●	●	●	●	●	A																							
	PB3CPM10	黒																												φ24	モメンタリ	1a	分離	●	●	●	●	●	●	A								
	PB3CPM11	黒		φ29	モメンタリ	1a	分離												●	●	●	●	●	●	A																							
	PB3CGM10	黒																												φ40	モメンタリ	1a	分離	●	●	●	●	●	●	A								
	PB3CGM11	黒		φ29	モメンタリ	1a	分離												●	●	●	●	●	●	A																							
PB3CG2M10	黒	φ40	モメンタリ					1a1b	分離	●	●	●	●	●	●	A																																
PB3MSM10	黒			φ29	モメンタリ	1a	分離												●	●	●	●	●	●	A																							
PB3MSM11	黒	φ40	モメンタリ					1a1b	分離	●	●	●	●	●	●	A																																
PB3MM10	黒			φ40	プッシュロック ターンリセット	1b	分離												●	●	●	●	●	●	A																							
PB3MM11	黒	φ40	プッシュロック ターンリセット					2b	分離	●	●	●	●	●	●	A																																
PB3PL01	黒			φ40	プッシュロック ターンリセット	1a1b	分離												●	●	●	●	●	●	A																							
PB3PL02	黒	φ40	プッシュロック ターンリセット					1a1b	分離	●	●	●	●	●	●	A																																
PB3PL11	黒			φ40	プッシュロック ターンリセット	1a1b	分離												●	●	●	●	●	●	A																							

■部 1~2個のご注文は通常単価+パラチャージを申し受けます。  
 【計算例】 PB3CFM10-R を2個ご注文の場合  
 (通常単価425円+パラチャージ420円)×2個=1,690円

詳細仕様

仕様グループ	定格絶縁電圧 (Ui)	定格通電電流 (Ith)	スイッチ回路定格				使用温度範囲 °C	絶縁抵抗 DC500V メガ	耐電圧 AC 1分間 V			耐久性(万回以上)				質量約g	
			定格使用電圧 (Ue)	定格使用電流		交流			直流	充電部アース間	異極充電部間	充電部非充電部間	機械的		電氣的		
				コイル負荷 (AC-15)	コイル負荷 (DC-13)								モメンタリ	オルタネイト	プッシュロック		電氣的
			24V	6A	4A	2500			2500	-	100	10	44	132			
A	AC DC 600V	10A	120V	6A	-	-20 ~ +70	100 MΩ 以上	2500	2500	-	100	10	44	132			
			125V	-	1.3A												
			240V	6A	-												
			250V	-	0.45A												
			480V	2.5A	-												
			600V	2A	-												
			24V	10A	5A										-20 ~ +50	500	50
48V	-	2A															
50V	7A	-															
110V	5A	1.1A															
220V	3A	0.6A															
440V	1A	-															

## 外形図

### PB3C\*M1\*

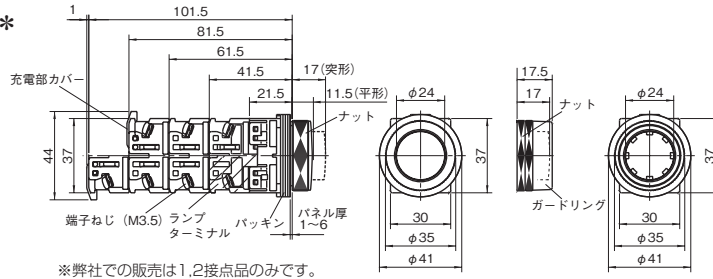

※弊社での販売は1,2接点品のみです。

### PB3PL\*\*

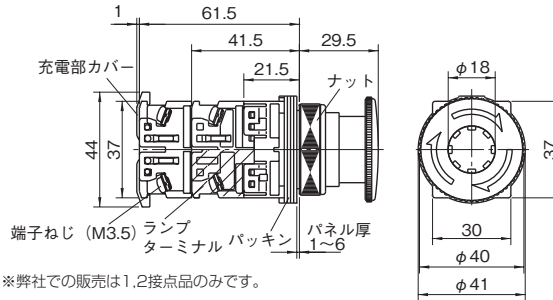

※弊社での販売は1,2接点品のみです。

## 端子配列

### PB3CF2\*\*\*以外

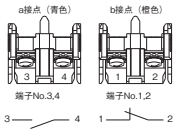

### PB3CF2\*\*\*

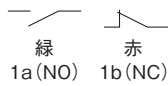

## パネルカット寸法

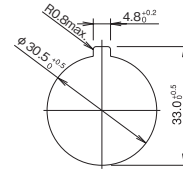

## 接点・トランス・ランプターミナルの交換

### ①取り外し

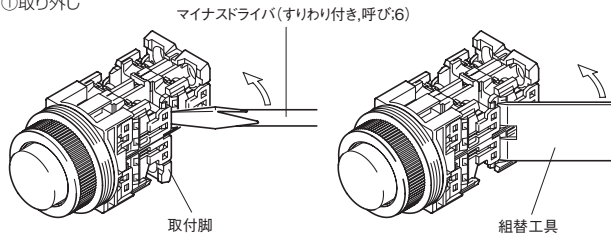

### ②取り付け

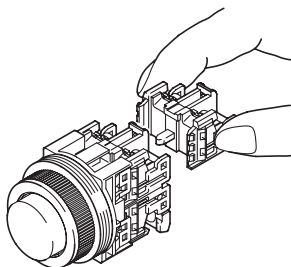

## 押しボタン

非常停止・安全スイッチ

セレクトスイッチ

ロックスイッチ

トグルスイッチ

スライドスイッチ

スイッチユニット

フットスイッチ

レバースイッチ

その他スイッチ

テープスイッチ

スイッチ用ツマミ

保護/スイッチカバー

スイッチガード

スイッチ用銘板

スイッチ周辺部品

スイッチ 海外規格番号

掲載頁	ミスマ型番	メーカー型番	UL/cUL	CSA	TUV	CCC	
0162	ELS12**	XA1ELV3**Q4R	E68961/E305148	-	-	2005010305150899	
	ELS14**	XA1ELV4**Q4R	E68961/E305148	-	-	2005010305150899	
	EL24**	HW1ELV4**Q4R	E55996	-	-	2004010305132908	
	ELS24**	XW1ELV4**Q4MR	E68961/E305148	-	-	2005010305150897	
	EL34**	HN1ELV4**Q4R	E55996	-	-	2004010305132910	
	ELS34**	XN1ELV4**Q4MR	E305148	-	-	-	
	EBS12**	XA1E-BV3**R	E68961/E305148	-	-	2005010305150899	
	EBS14**	XA1E-BV4**R	E68961/E305148	-	-	2005010305150899	
	EBS1401EG	XA1E-BV401RH-EMO (本線のみ)	E68961/E305148	-	-	2005010305150899	
	EBB22**	HW1E-BV3**R	E68961	LR92374	-	2005103050145656	
0164	EB24**	HW1E-BV4**R	E55996	-	-	2004010305132908	
	EBB24**	HW1E-BV4**R	E68961	LR92374	-	2005103050145656	
	EBS24**	XW1E-BV4**MR	E68961/E305148	-	-	2005010305150897	
	EBS2411EG	HW1E-BV411RH-EMO (本線のみ)	E68961/E305148	-	-	2005010305150897	
	EB34**	HN1E-BV4**R	E55996	-	-	2004010305132910	
	EBS34**	XN1E-BV4**MR	E305148	-	-	-	
	0139	PL1SRF16**	AR16F-M-C1E3*	E44592	-	R50116759	2003010305071068
		PL1BRF11**	AH16*-TL*11E3	E44592	LR20479	R9250087	2003010305071068
		PL1SRF14**	AL6H*14**	E55996	LR92374	-	2003010305027381
		PL1SSF16**	AR16F-M-C1E3*	E44592	-	R50116759	2003010305071068
PL1BSF11**		AH16*-SL*11E3	E44592	LR20479	R9250087	2003010305071068	
PL1SSF14**		AL6G*14**	E55996	LR92374	-	2003010305027381	
PL1SCP16**		AR16E-L-C1E3*	E44592	-	R50116759	2003010305071068	
PL1BCPM11**		AH16*-ML*11E3	E44592	LR20479	R9250087	2003010305071068	
PL1SCP14**		AL6M*14**	E55996	LR92374	-	2003010305027381	
PL2CF1**		AR22F-ML*1*E3*	E44592	LR20479	R9551062	2003010305063372	
0145	PL2CP1**	AR22E-ML*1*E3*	E44592	LR20479	R9551062	2003010305063372	
	PL2CP1-1**	LW1L*2C14*	E55996	LR21451	J9551801	-	
	PL2CGM1**	AR22GAL*1*E3*	E44592	LR20479	R9551062	2003010305063372	
	PL2SFM1**	AR22FOM*1*E3*	E44592	LR20479	R9551062	2003010305063372	
	PL2SF1**	LW2L*1C14*	E55996	LR21451	J9551801	-	
	PL2SPM1**	AR22EOM*1*E3*	E44592	LR20479	R9551062	2003010305063372	
	PL2M1**	AR22M-ML*1*E3*	E44592	LR20479	R9551062	2003010305063372	
	PL3CP1**	AR30E-ML*1*E3*	E44592	LR20479	R9551062	2003010305063384	
	PL3CGM1**	AR30GAL*1*E3*	E44592	LR20479	R9551062	2003010305063384	
	PL3PL**	AR30VSL*1*E3*	E44592	LR20479	R9551062	2003010305063384	
0153	PB1SRF16**	AR16F-T-C1*	E44592	-	R50116759	2003010305071068	
	PB1BRF11**	AH16*-TF*11	E44592	LR20479	R9250087	2003010305071068	
	PB1SSF16**	AR16F-S-C1*	E44592	-	R50116759	2003010305071068	
	PB1BSFM11**	AH16*-SF*11	E44592	LR20479	R9250087	2003010305071068	
	PB1BSP16**	HA2B*2C1*	E55996	LR21451	-	-	
	PB1SCP16**	AR16E-F-C1*	E44592	-	R50116759	2003010305071068	
	PB1BCPM11**	AH16*-E*11	E44592	LR20479	R9250087	2003010305071068	
	PB1BM16**	HA1B*3C1*	E55996	LR21451	-	-	
	PB1BM11**	AH16*-M*11	E44592	LR20479	R9250087	2003010305071068	
	PB1BPL0*6	AH16S-VRO*6	E44592	LR20479	R9250087	2003010305071068	
0147	PB1BPL0*6	AH16S-V1RO*	E44592	LR20479	R9250087	2003010305071068	
	PB2CF1**	AR22F-FR*1**	E44592	LR20479	R9551062	2003010305063372	
	PB2CF2M**	ABW1**	E68961	LR21451	-	-	
	PB2CF2A**	AOW1**	E68961	LR21451	-	-	
	PB2CPM1**	AR22EOR*1**	E44592	LR20479	R9551062	2003010305063372	
	PB2CGM1**	AR22G3R*1**	E44592	LR20479	R9551062	2003010305063372	
	PB2CG2M1**	AR22M3R*1**	E44592	LR20479	R9551062	2003010305063372	
	PB2MSM1**	AR22M4R*1**	E44592	LR20479	R9551062	2003010305063372	
	PB2MM1**	AR22MOR*1**	E44592	LR20479	R9551062	2003010305063372	
	PB2SFM1**	AR22FOS*1**	E44592	LR20479	R9551062	2003010305063372	
0155	PB2SPM1**	AR22EOS*1**	E44592	LR20479	R9551062	2003010305063372	
	PB3CFM1**	AR30FOR*1**	E44592	LR20479	R9551062	2003010305063384	
	PB3CF2M**	ABN1**	E68961	LR21451	-	2005010305145658	
	PB3CF2A**	AON1**	E68961	LR21451	-	2005010305145658	
	PB3CPM1**	AR30EOR*1**	E44592	LR20479	R9551062	2003010305063384	
	PB3CGM1**	AR30G1R*1**	E44592	LR20479	R9551062	2003010305063384	
	PB3CG2M1**	AR30M3R*1**	E44592	LR20479	R9551062	2003010305063384	
	PB3MSM1**	AR30M4R*1**	E44592	LR20479	R9551062	2003010305063384	
	PB3MM1**	AR30MOR*1**	E44592	LR20479	R9551062	2003010305063384	
	PB3PL**	AR30VSR*1**	E44592	LR20479	R9551062	2003010305063384	
0189	SB1R214	AS6H-2Y1	E55996	LR92374	-	2003010305027381	
	SB1R216	AR16PT-2C1B	E44592	-	R50116759	2003010305071068	
	SB1R211**	AH16*-PB211	E44592	LR20479	R9250088	2003010305071068	
	SB1R324	AS6H-3Y2	E55996	LR92374	-	2003010305027381	
	SB1R326	AR16PT-3C2B	E44592	-	R50116759	2003010305071068	
	SB1R322**	AH16*-PK3B22	E44592	LR20479	R9250088	2003010305071068	

掲載頁	ミスマ型番	メーカー型番	UL/cUL	CSA	TUV	CCC
0189	SB1S214	AS6Q-2Y1	E55996	LR92374	-	2003010305027381
	SB1S216	AR16PS-2C1B	E44592	-	R50116759	2003010305071068
	SB1S211**	AH16*-SP211	E44592	LR20479	R9250088	2003010305071068
	SB1S324	AS6Q-3Y2	E55996	LR92374	-	2003010305027381
	SB1S326	AR16PS-3C2B	E44592	-	R50116759	2003010305071068
	SB1S322**	AH16*-SPK3B22	E44592	LR20479	R9250088	2003010305071068
	SB1C214	AS6M-2Y1	E55996	LR92374	-	2003010305027381
	SB1C216	AR16PR-2C1B	E44592	-	R50116759	2003010305071068
	SB1C324	AS6M-3Y2	E55996	LR92374	-	2003010305027381
	SB1C326	AR16PR-3C2B	E44592	-	R50116759	2003010305071068
0195	SB2BC210	AR22PR-210B	E44592	LR20479	R9551060	2003010305063372
	SB2C210	ASW210	E68961	LR21451	-	2003010305027380
	SB2C211	AR22PR-211B	E44592	LR20479	R9551060	2003010305063372
	SB2C211	ASW211	E68961	LR21451	-	2003010305027380
	SB2C320	ASW320	E68961	LR21451	-	2003010305027380
	SB2BC311	AR22PR-311B	E44592	LR20479	R9551060	2003010305063372
	SB2BC322	AR22POR-3014B	E44592	LR20479	R9551060	2003010305063372
	SB3BC210	AR30PR-210B	E44592	LR20479	R9551060	2003010305063384
	SB3C210	ASN310	E68961	LR21451	-	2005010305145658
	SB3C211	AR30PR-211B	E44592	LR20479	R9551060	2003010305063384
0281	SB3C211	ASN311	E68961	LR21451	-	2005010305145658
	SB3C311	ASN111	E68961	LR21451	-	2005010305145658
	SB3BC311	AR30PR-311B	E44592	LR20479	R9551060	2003010305063384
	SB3BC322	AR30PR-322B	E44592	LR20479	R9551060	2003010305063384
	SB1R216-KL	AH16JT-2AC1A	E44592	-	R50116759	2003010305071068
	SB1R216-KA	AH16JT-2BC1A	E44592	-	R50116759	2003010305071068
	SB1R214-KL	AH164-J2A11A	E44592	LR20479	R9250088	2003010305071068
	SB1R214-KA	AH164-J2B11A	E44592	LR20479	R9250088	2003010305071068
	SB1S216-KL	AH16S-J2A11A	E44592	LR20479	R9250088	2003010305071068
	SB1S216-KA	AH16S-J2B11A	E44592	LR20479	R9250088	2003010305071068
0281	SB2B210-KL	AR22JR-2A10A	E44592	LR20479	R9551060	2003010305063372
	SB2B210-KA	AR22JR-2B10A	E44592	LR20479	R9551060	2003010305063372
	SB2B211-KL	AR22JR-2A11A	E44592	LR20479	R9551060	2003010305063372
	SB2B211-KA	AR22JR-2B11A	E44592	LR20479	R9551060	2003010305063372
	SB2B311-KL	AR22JR-3A11A	E44592	LR20479	R9551060	2003010305063372
	SB2B311-KA	AR22JR-3C11A	E44592	LR20479	R9551060	2003010305063372
	SB2C210-KL	AR30JR-2A10A	E44592	LR20479	R9551060	2003010305063384
	SB2C210-KA	AR30JR-2B10A	E44592	LR20479	R9551060	2003010305063384
	SB2C211-KL	AR30JR-2A11A	E44592	LR20479	R9551060	2003010305063384
	SB2C211-KA	AR30JR-2B11A	E44592	LR20479	R9551060	2003010305063384
0281	SB2C311-KL	AR30JR-3A11A	E44592	LR20479	R9551060	2003010305063384
	SB2C311-KA	AR30JR-3C11A	E44592	LR20479	R9551060	2003010305063384
	SB3C210-KL	AR30JR-2A10A	E44592	LR20479	R9551060	2003010305063384
	SB3C210-KA	AR30JR-2B10A	E44592	LR20479	R9551060	2003010305063384
	SB3C211-KL	AR30JR-2A11A	E44592	LR20479	R9551060	2003010305063384
	SB3C211-KA	AR30JR-2B11A	E44592	LR20479	R9551060	2003010305063384
	SB3C311-KL	AR30JR-3A11A	E44592	LR20479	R9551060	2003010305063384
	SB3C311-KA	AR30JR-3C11A	E44592	LR20479	R9551060	2003010305063384
	L1RF244**	AH164-ZT*E3	E44592	LR20479	R9250089	2003010305071044
	L1RF246**	AH165-ZT*E3	E44592	LR20479	R9250089	2003010305071044
L1SRF246**	DR16FOM-E3*	E44592	-	R50116762	2003010305071044	
L1SF110**	AH16*-ZS*H3	E44592	LR20479	R9250089	2003010305071044	
L1SF220**	AH16*-ZS*H3	E44592	LR20479	R9250089	2003010305071044	
L1CP24**	AH16*-Z*E3	E44592	LR20479	R9250089	2003010305071044	
L1SCP246**	DR16EOL-E3*	E44592	-	R50116762	2003010305071044	
L1CP110**	AH16*-Z*H3	E44592	LR20479	R9250089	2003010305071044	
L1CP220**	AH16*-Z*H3	E44592	LR20479	R9250089	2003010305071044	
0281	L1D246**	DR16DOL-E3*	E44592	-	R50116762	2003010305071044
	L2D24**	DR22E3L-E3*	E44592	LR20479	R9551061	2003010305063383
	L2D224**	APW222D*	E68961	LR21451	-	2007010304226713
	L2D110**	DR22DOL-H3*	E44592	LR20479	R9551061	2003010305063383
	L2D2110**	APW2116D*	E68961	LR21451	-	2007010304226713
	L2D220**					