

GEAR MOTOR

OUTPUT (kW)	TYPE	FORM	RATING	VOLTAGE (V)	FREQ. (Hz)	SPEED (min ⁻¹)	POLES	TH. CLASS	MASS (kg)
7.5	TFOG	KK	S1	380/415	50	50	4	F	132

MODEL NO.
GH60-750-30

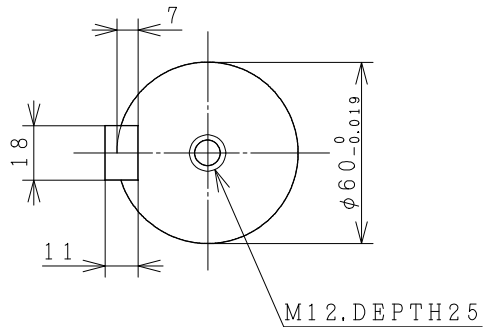
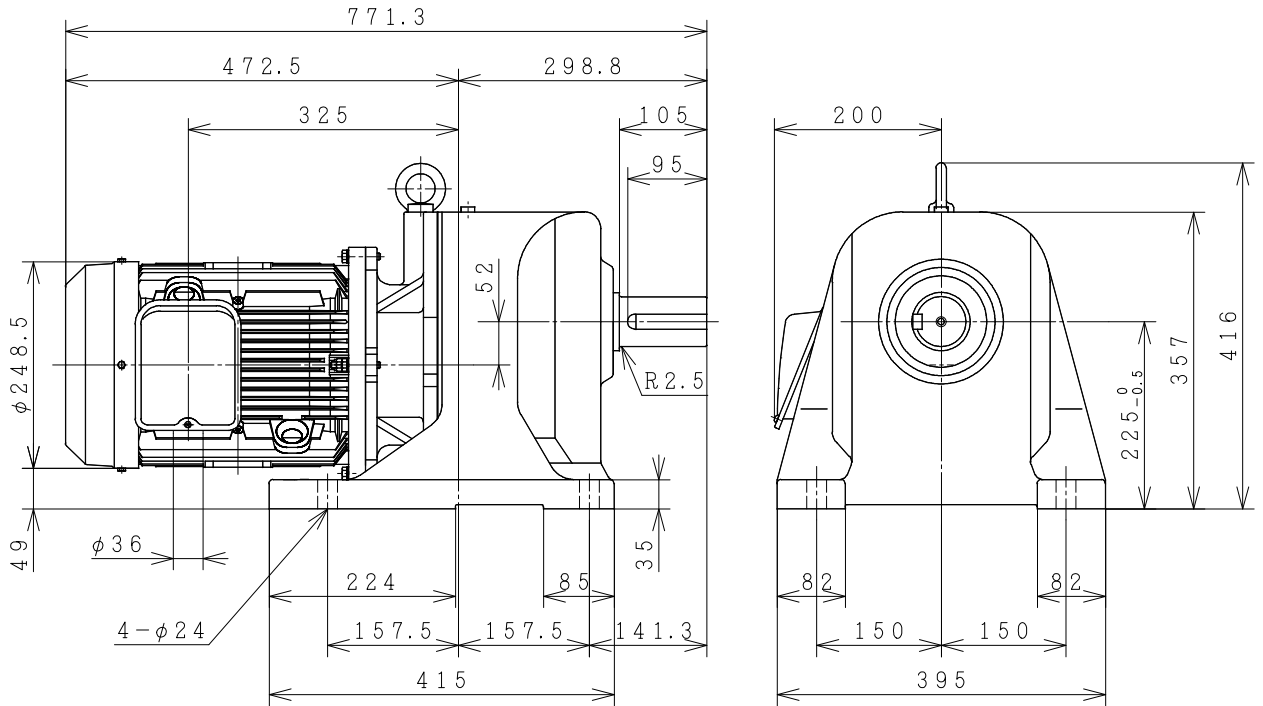

PROJECTION

CUSTOMER			QTY.	ORDER No.	WORK No.	REV.
DWN.	D. ITTIDECH	27-Jul-2015	<div style="display: flex; justify-content: space-around; align-items: center;"> <div style="font-size: 2em; font-weight: bold;">DIMENSIONS</div> <div style="text-align: center;"> <small>Hitachi Industrial Technology (Thailand), Ltd.</small> </div> <div style="font-size: 1.5em; font-weight: bold;">4HTD03146</div> </div>			SH.
CHKD.	M. KAMIZONO	S				
APPD.	M. KAMIZONO					
FRAME SIZE (GH) 7.5 kW 1/30						