

# GEAR MOTOR

OUTPUT (kW)	TYPE	FORM	RATING	VOLTAGE (V)	FREQ. (Hz)	SPEED (min <sup>-1</sup> )	POLES	TH. CLASS	MASS (kg)
0.75	TFOG	K	S1	220/380	50	33	4	F	29

MODEL NO.

GH38-075-45

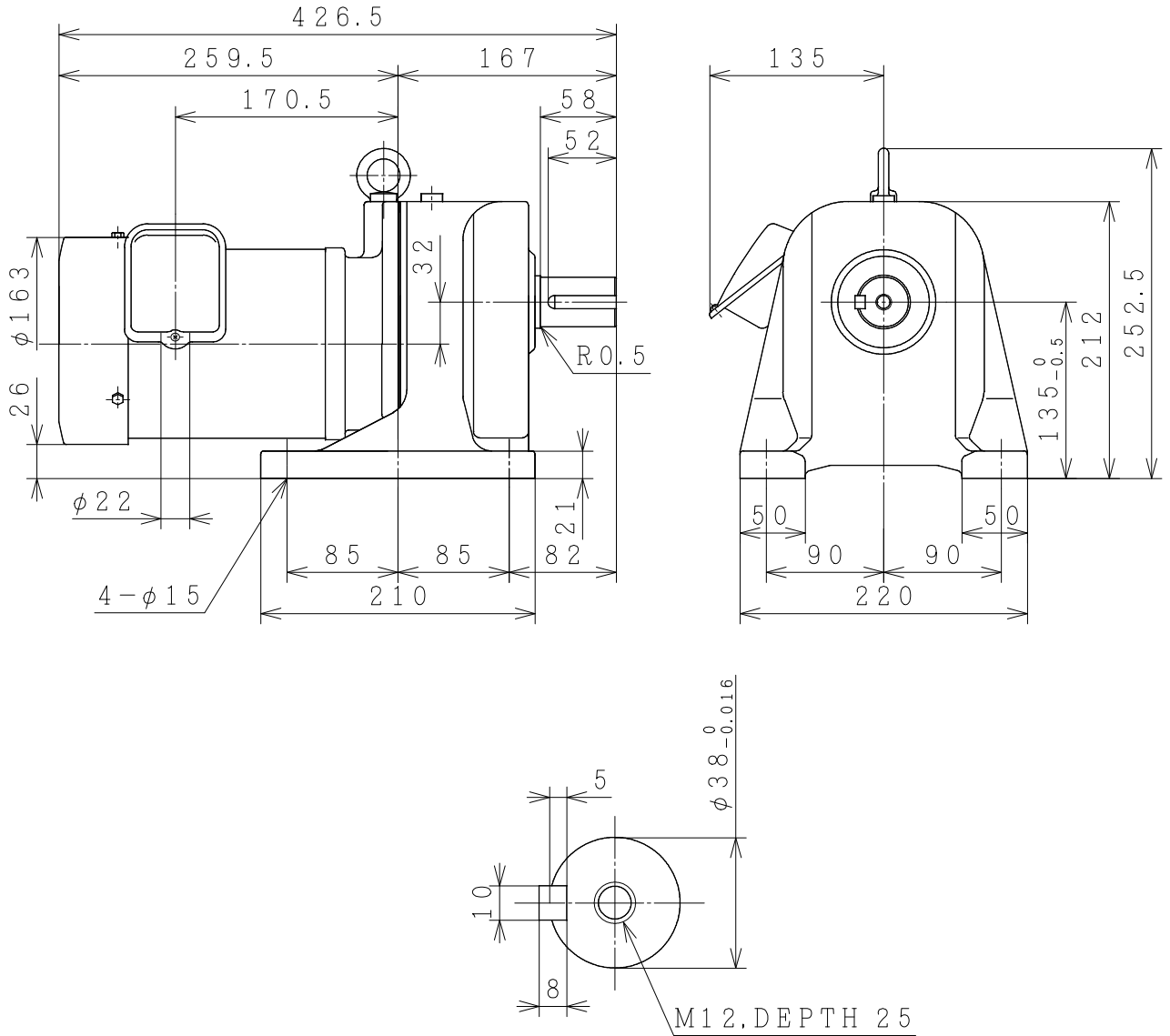

PROJECTION

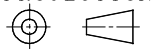

CUSTOMER			QTY.	ORDER No.	WORK No.	REV.	
DWN.	D. ITTIDECH	29-Jul-2015	<div style="display: flex; justify-content: space-around; align-items: center;"> <div style="font-size: 2em; font-weight: bold;">DIMENSIONS</div> <div style="text-align: center;"> <b>HITACHI</b>  <small>Hitachi Industrial Technology (Thailand), Ltd.</small> </div> <div style="font-size: 1.5em; font-weight: bold;">4HTD03160</div> </div>			HITT WORKS DWG. No.	SH.
CHKD.	M. KAMIZONO	S					
APPD.	M. KAMIZONO						
FRAME SIZE			(GH) 0.75kW 1/45				