

Wheel Conveyor Assembly / Connecting Parts / Wheel Conveyors

Note that, for some of the types shown here, order might be unable to be received by the MISUMI Indonesia, and/or India offices.

Skid Conveyor Rails / Connecting Parts / Lifting Table Units

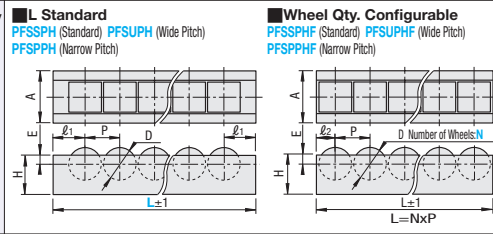
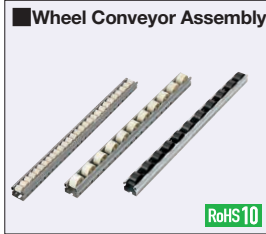

Part Number	Material	Surface Treatment
PFSSPH	Edge: SPCC Wheel: Polyacetal Shaft: Polyacetal	Non-chrome Hot Dip Galvanizing
PFSPPH	Edge: SPHC Wheel: Polypropylene	Non-chrome Hot Dip Galvanizing

Part Number	L	Actual Length L (mm)	A	H	E	P	D	ℓ1	Wheel (Qty.)	Mass (kg)	Allowable Load (per Wheel)	Connecting Parts	Unit Price 1-49 pc(s)	Volume Discount Rate 50-100
PFSSPH (Standard)	2000	1992	40	30	6.5	27	25	24	73	2.12	5kg	JBS50□	3,200	3,040
	2400	2397							88	2.56			3,800	3,610
	3000	2991							110	3.20			4,750	4,510
PFSPPH (Narrow Pitch)	2000	2000							99	2.50	7kg	JBS50□A	4,750	4,510
	2500	2500	40.1	31.6	4	20	18	10	124	3.13			5,900	5,600
	3000	3000							149	3.75			7,100	6,740
PFSUPH (Wide Pitch)	2000	2000							39	2.36	10kg		3,900	3,700
	2500	2500	40.1	31.6	4	50	36	25	49	2.95			4,900	4,650
	3000	3000							59	3.54			5,900	5,600

Ordering Example

Part Number - L - N

PFSSPH - 2400 - 50

Part Number	Number of Wheels N	A	H	E	P	D	ℓ2	Mass (kg/m)	Allowable Load (per Wheel)	Connecting Parts	Unit Price 1-5 pc(s)	Volume Discount Rate Wheel 1 pc. Cutting Charge
PFSSPHF	5-110	40	30	6.5	27	25	13.5	1.1	5kg	JBS50□		
PFSPPHF	5-149	40.1	31.6	4	20	18	10	1.25	7kg	JBS50□A		
PFSUPHF	5-59	40.1	31.6	4	50	36	25	1.18	10kg			

Connecting Parts

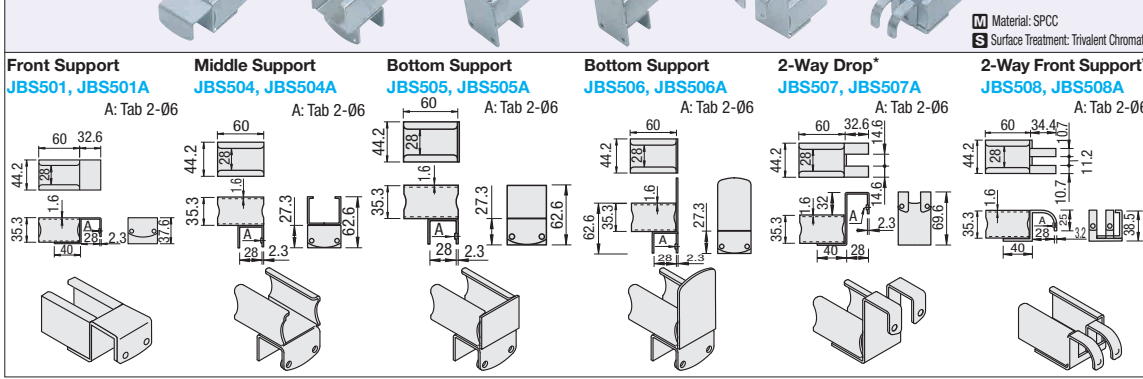

Part Number	Mass (g)	Unit Price 1-49 pc(s)	Volume Discount Rate 50-100
JBS501 JBS501A	180		
JBS504 JBS504A	146		
JBS505 JBS505A	168		
JBS506 JBS506A	192		
JBS507 JBS507A	184		
JBS508 JBS508A	164		

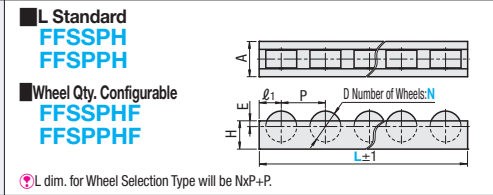

Part Number	Material	Surface Treatment
FFSSPH	Edge: A6N01SS-T5	Clear Anodize
FFSPPH	Wheel: Polyacetal	-
FFSPPHF	Shaft: SWRM	-

Part Number	L	Nominal Length	A	H	E	P	D	ℓ1	Wheel (Qty.)	Mass (kg)	Allowable Load (per Wheel)	Unit Price 1-49 pc(s)	Volume Discount Rate 50-100
FFSSPH (Economy Type)	1000		40	32	5	50	35	25	20	1.84	10kg		
	1500								30	2.76			
	3000								60	5.52			
FFSPPH (Narrow Pitch)	1000		40	32	5	15	13	10	67	6.39	7kg		
	1500								100	9.42			
	3000								200	18.6			

Part Number	Number of Wheels N	Mass (kg/m)	Allowable Load (per Wheel)	Connecting Parts	Unit Price 1-100 pc(s)	Volume Discount Rate Wheel 1 pc. Cutting Charge
FFSSPHF	5-110	1.84	10kg	JBS50□_A		
FFSPPHF	5-110	6.39	7kg	JBS50□_A		

Ordering Example

Part Number - L - N

FFSSPH - 3000 - 10

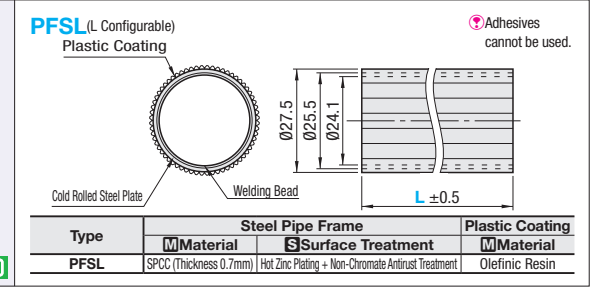

Part Number	Color	L	Mass	Unit Price / m
PFSL	28 (Ivory)	150-3000	0.53	

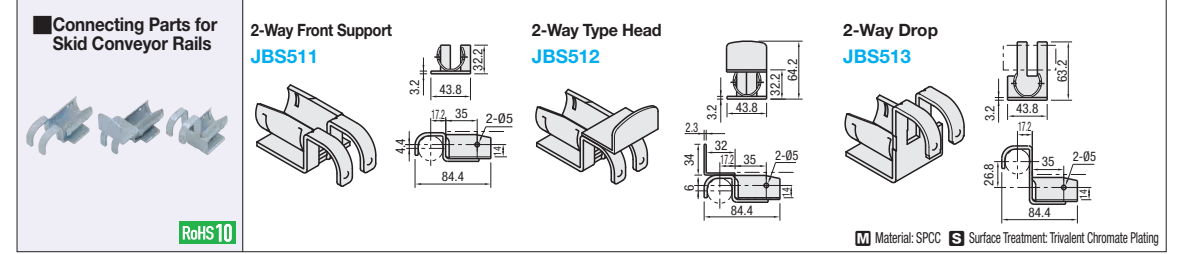

Part Number	Mass (g)	Unit Price 1-49 pc(s)	Volume Discount Rate 50-100
JBS511	120		
JBS512	168		
JBS513	158		

Ordering Example

Part Number - Color - L

PFSL28 - F - 1250

Skid Conveyor Rails

Chutes can be configured more economically with skid conveyor rails than wheel conveyor units. Skid conveyor rails are rails with grooves on surface. Plastic containers slide on skid conveyor rails easily.

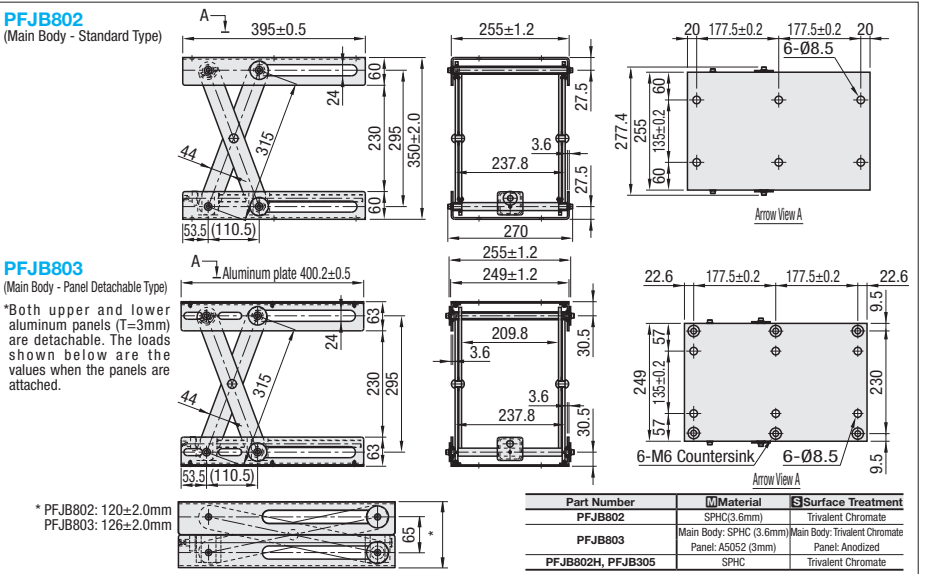

Part Number	Static Load (kg)	Dynamic Load (kg)	Mass	Unit Price 1-19 pc(s)	Volume Discount Rate 20-100
PFJB802 (Main Body - Standard Type)	100	80	12.5kg		
PFJB803 (Main Body - Panel Detachable Type)	60	50	10.3kg		
PFJB802H (Handle)	-	-	444g		
PFJB305 (Saddle)	-	-	53g		

* PFJB802: 120±2.0mm
PFJB803: 126±2.0mm

Ordering Example

Part Number

PFJB802

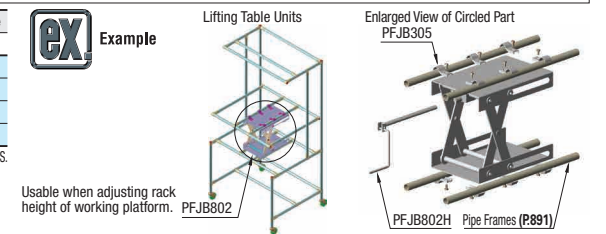

Usable when adjusting rack height of working platform.

Part Number	Material	Surface Treatment
PFJB802	SPHC(3.6mm)	Trivalent Chromate
PFJB803	Main Body: SPHC (3.6mm) Panel: A5052 (3mm)	Main Body: Trivalent Chromate Panel: Anodized
PFJB802H, PFJB305	SPHC	Trivalent Chromate