

Pre-Assembly Insertion Nuts / Stoppers for Aluminum Extrusions - Others

For 8 Series (Slot Width 10mm)

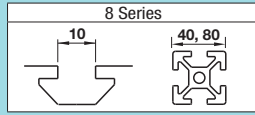

Post-Assembly Insertion Nuts / Stoppers for Aluminum Extrusions - Standard

For 8 Series (Slot Width 10mm)

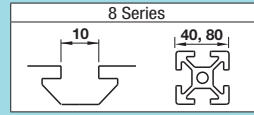

Pre-Assembly Insertion Lock Nuts

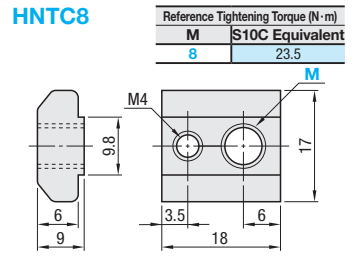

Example • Pre-Assembly Insertion Lock Nuts
The position of post-assembly insertion lock nuts can be fixed temporarily with the set screw.

Part Number	M	Accessory	Unit Price (1-499 pcs)	Volume Discount Rate
HNTC8	8	M4x6 Set Screw for Locking 1 pc.		500-749 750-999 1000-1500

Pre-Assembly Insertion Short Nuts

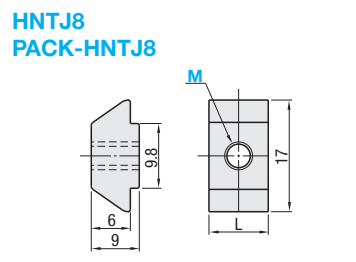

• Overall length is shorter than Pre-Assembly Insertion Nuts HNTT. Suitable for installing sensors or other components closely together.
• Stopper is not included.

Ordering Example: Part Number - M
HNTJ8 - 8
HNTJ8 - 4

Part Number	M	L	HNTJ8			PACK-HNTJ8		
			Unit Price (1-499 pc(s))	Volume Discount Rate		Unit Price (1-9 pkg(s))	Volume Discount Rate	
HNTJ8 PACK-HNTJ8	3	8						
	4							
	8	12						

100 pcs. per package

Pre-Assembly Insertion Offset Nuts

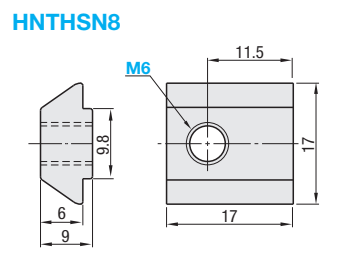

Example The pre-assembly insertion offset nut, used in combination with a post-assembly insertion double joint, can be fixed in such a way that the nut, even if connected at the corner of the extrusion, does not protrude from the extrusion frame.

With HNTHSN

Part Number	Unit Price (1-150 pc(s))
HNTHSN8	

Pre-Assembly Insertion Square Nuts

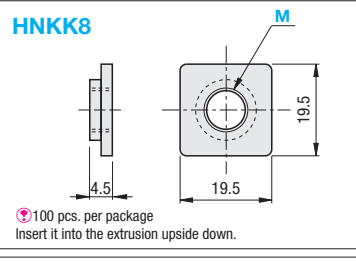

Example • Pre-Assembly Insertion Nuts

Part Number	M	Unit Price (1-9 pkg(s))	Volume Discount Rate
HNKK8	4 5 6 8		10-19 20-30

Metal Stoppers for Pre-Assembly Insertion Square Nuts

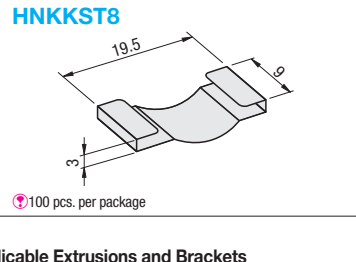

Example

Part Number	Applicable Pre-Assembly Insertion Nut	Unit Price (1-9 pkg(s))	Volume Discount Rate
HNKKST8	HNKK8		10-19 20-30

Ordering Example: Part Number - M
HNTHSN8 - 8
HNKK8 - 8
HNKKST8 - 8

• Applicable Extrusions and Brackets
Applicable to extrusions and brackets with the same part number.
(Ex.) Part Number
Pre-Assembly Insertion Nuts HNTT8 - □
Pre-Assembly Insertion Stoppers HNST8 - □
Extrusion HFS8 - □□□□
Brackets HBLFSN8

Post-Assembly Insertion Stopper Nuts

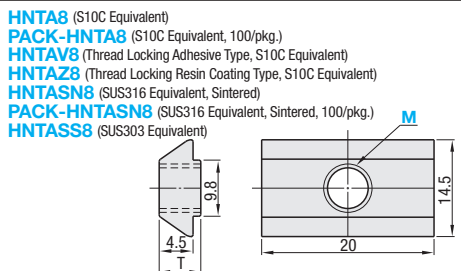

• Post-Assembly Insertion Stopper Nuts

Type	M	Material	S
① HNTA8		S10C Equivalent	Trivalent Chromate
② PACK-HNTA8			
③ HNTAV8			
④ HNTAZ8			
⑤ HNTASN8*		SUS316 Equivalent (Sintered)	
⑥ PACK-HNTASN8*			
⑦ HNTASS8		SUS303 Equivalent	

Reference Tightening Torque (N·m)
M S10C Equivalent / SUS316 Equivalent (Sintered) / SUS303 Equivalent
8 23.5

Part Number	Type	M	T	Unit Price			Volume Discount Rate		
				1-499 pc(s)	500-749	750-999	1000-1500		
HNTA8	(S10C Equivalent)	4 5 6 8	6.5						
HNTAV8	(Thread Locking, S10C Equivalent)	8							
HNTAZ8	(Thread Locking, S10C Equivalent)	8							
HNTASN8	(SUS316 Equivalent, Sintered)	4 5 6 8	6.0						
HNTASS8	(SUS303 Equivalent)	8	6.5						

100 pcs. per package

Part Number	Type	M	Unit Price (1-10 packages)	
			Package Price	Price per Pkg.
PACK-HNTA8	(S10C Equivalent)	4 5 6 8		
PACK-HNTASN8	(SUS316 Equivalent, Sintered)	4 5 6 8		

Post-Assembly Insertion Stoppers

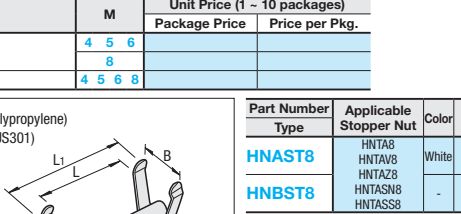

• Post-Assembly Insertion Stoppers

Part Number	Applicable Stopper Nut	Color	L	B	L1	B1	Unit Price (1-499 pc(s))	Volume Discount Rate
HNAST8	HNTA8 HNTAV8 HNTAZ8	White	21	11.1	26	9.8		
HNBST8	HNTASN8 HNTASN8*	-	23	12.5	28	8		

Post-Assembly Insertion Nut and Stopper Set

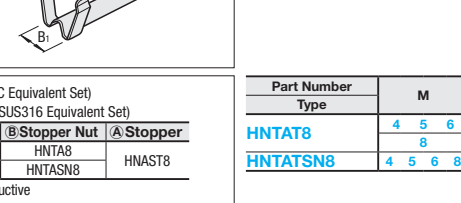

• Post-Assembly Insertion Nut and Stopper Set

Part Number	M	Unit Price (1-499 pc(s))	Volume Discount Rate
HNTAT8	4 5 6 8		500-749 750-999 1000-1500
HNTATS8	4 5 6 8		

Post-Assembly Insertion Nut and Metal Stopper Set

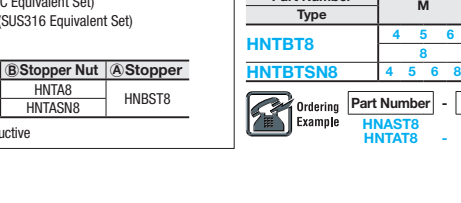

• Post-Assembly Insertion Nut and Metal Stopper Set

Part Number	M	Unit Price (1-499 pc(s))	Volume Discount Rate
HNTBT8	4 5 6 8		500-749 750-999 1000-1500
HNTBTS8	4 5 6 8		

Post-Assembly Insertion Nuts

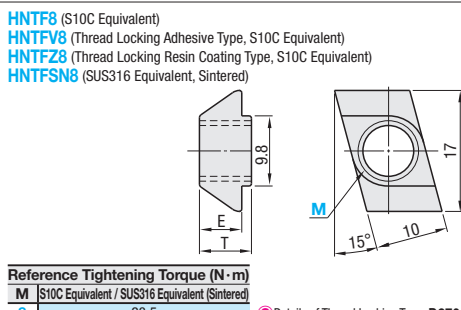

• Post-Assembly Insertion Nuts

Type	M	Material	S
① HNTF8		S10C Equivalent	Trivalent Chromate
② HNTFV8			
③ HNTFZ8			
④ HNTFSN8*		SUS316 Equivalent (Sintered)	

Reference Tightening Torque (N·m)
M S10C Equivalent / SUS316 Equivalent (Sintered)
8 23.5

Part Number	Type	M	E	T	Unit Price			Volume Discount Rate		
					1-499 pc(s)	500-749	750-999	1000-1500		
HNTF8	(S10C Equivalent)	4 5 6 8	6.0	9.0						
HNTFV8	(Thread Locking, S10C Equivalent)	8								
HNTFZ8	(Thread Locking, S10C Equivalent)	8								
HNTFSN8	(SUS316 Equivalent, Sintered)	4 5 6 8	6.4	8.9						

Post-Assembly Insertion Stoppers

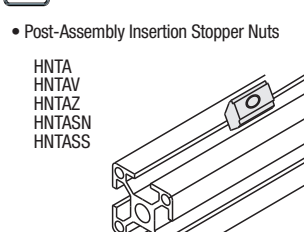

• Post-Assembly Insertion Stoppers

Part Number	M	Unit Price (1-499 pc(s))	Volume Discount Rate
HNTA8	4 5 6 8		500-749 750-999 1000-1500

Ordering Example: Part Number - M
HNTA8 - 8

Ordering Example: Part Number - M
HNAST8
HNTAT8 - 8

Ordering Example: Part Number - M
HNAST8
HNTAT8 - 8

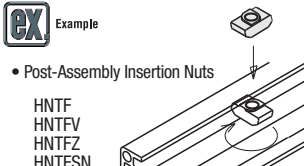

• Post-Assembly Insertion Nuts

Part Number	M	Unit Price (1-499 pc(s))	Volume Discount Rate
HNTF8	4 5 6 8		500-749 750-999 1000-1500

Ordering Example: Part Number - M
HNTF8 - 8